

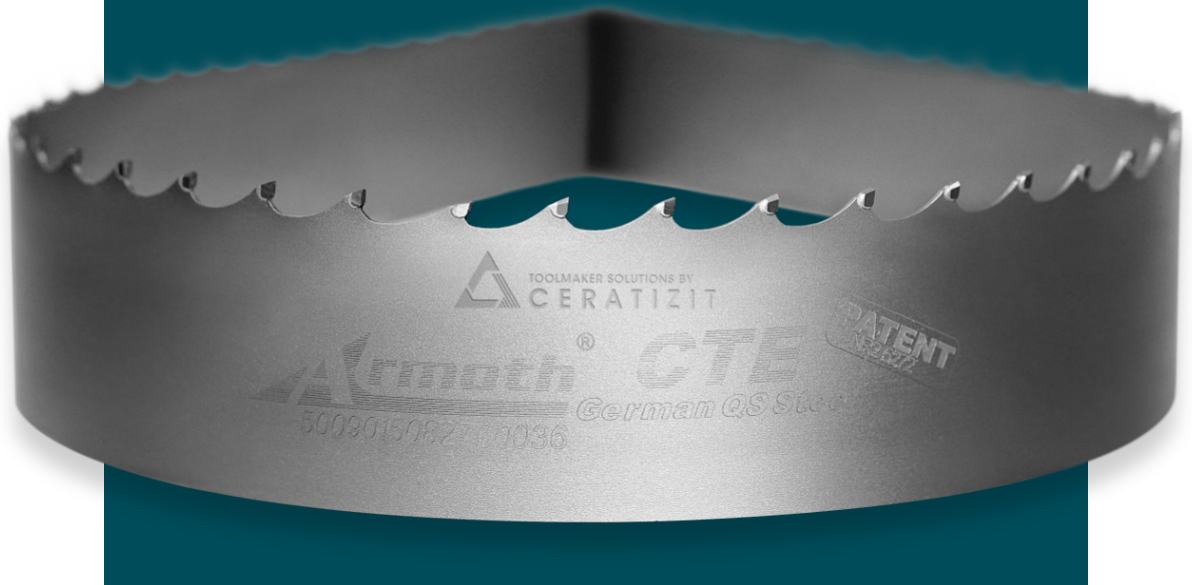

ARMOTH PROFESSIONAL BAND SAW BLADES FOR WOOD

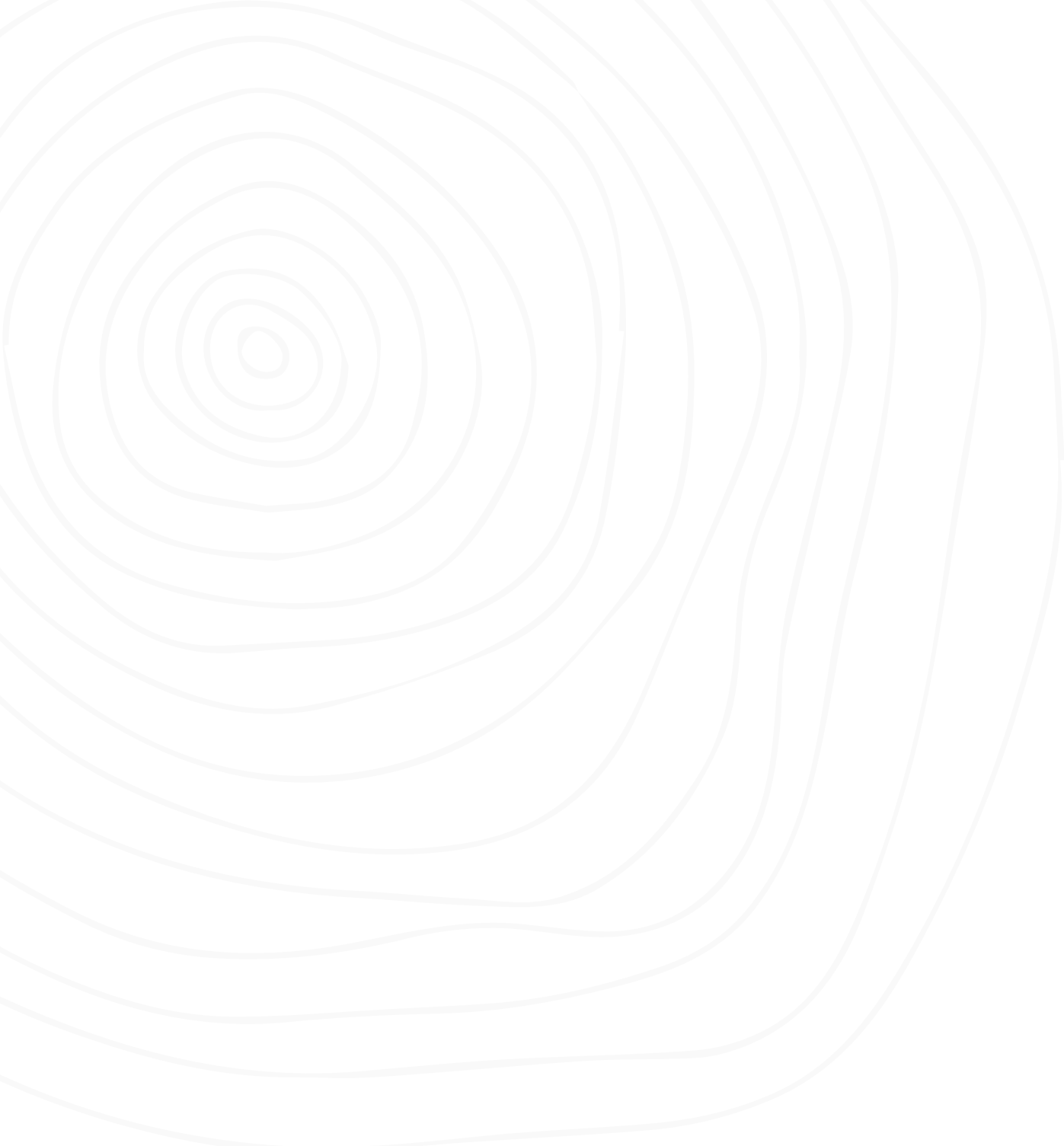



The main goal of QSGS Technology is to manufacture high-quality band saw blades that contribute to our customers' productivity and cost efficiency, increasing the competitiveness of their companies.





MANUFACTURER OF CUTTING TOOLS FOR THE WOOD INDUSTRY



About us

QSGS Technology was founded in 1995. From the very beginning, our company is focused on continuous development, technological progress and innovative thinking regarding the manufacturing technology of our tools.

The company name – Quality of Swedish German and Swiss Technology – is a reflection of our business partners who are world's leaders in the field of providing technology.

We have one of the most technologically advanced on-site research laboratories in the industry, with the measurement accuracy of 1 μm (1/1000 mm), including non-contact measurements. We continuously oversee production process of each blade, control the quality of supplied production materials and test technical parameters of finished products. In the long term this results in consistent quality of products which brings the satisfaction of our customers.

Individual needs of each and every client inspire our innovative thinking and the search for new technical solutions.

Over twenty years of systematic growth and successful technological development enables us to offer you an extensive range of cutting tools and a complex customer service – personalised according to yours needs.

BAND SAW BLADES FOR WOOD

ARMOTH PROFESSIONAL

As a result of a significant change of the production process, QSGS Technology introduces new and improved product - band saw blades for wood with increased efficiency of the cutting process.

Armoth Professional band saw blades for wood enable our Clients to increase the efficiency of the cutting process up to 50%. They are characterised by higher material feed rate (up to 30 m/min) and higher linear cutting speed (up to 50 m/s). Depending on the type, they have longer work hours between servicing, from 4 to 20.

Band saw blades for wood with increased efficiency of the cutting process are divided into three groups: monolithic band saw blades, bimetal band saw blades and carbide-tipped band saw blades.

For the manufacturing process of Armoth Professional band saw blades we use high-alloy spring steel QSX, with an individually selected chemical composition that is protected by a patent. Additionally, the band saw blades go through different QSGS Technology patent-protected production processes.

The entire manufacturing process is supervised and examined by engineers from our factory laboratory.

Armoth Professional band saw blades are tools for leaders of professional wood cutting.



TECHNICAL SPECIFICATION	WORKING CONDITIONS
Steel grade / Blade hardness: QSX / 460 - 490 HV	Blade tension: acc. to technical specification of machine manufacturer
Tooth type / Tooth hardness: Carbide / 1610 - 1750 HV	Feed rate: Up to 40 m/min
Tooth rake angle: 10 / 20 12 / 20 20 / 20	Blade speed: Up to 50 m/s
	Working time: up to 20 h between servicing



WIDTH H (mm)	THICKNESS T (mm)		PITCH P (mm)	
	0,9	1,1	19	22
38	✓		✓	
38		✓		✓
50	✓		✓	

On request we provide band saw blades of different dimensions.

■ SHARPENING (TOOTH)

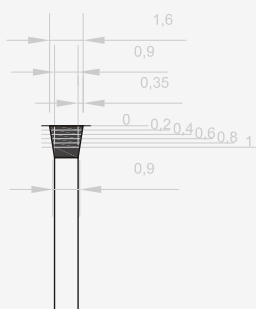

■ SHARPENING (TOOTH GULLET)

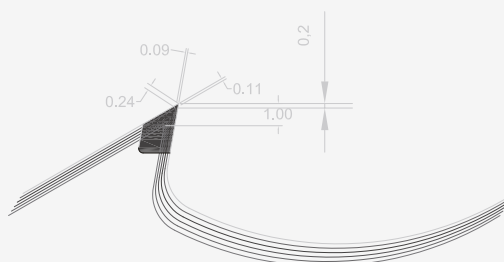

■ ADJUSTMENT OF THE TOOTH ROOT REGARDING THE ROLLER

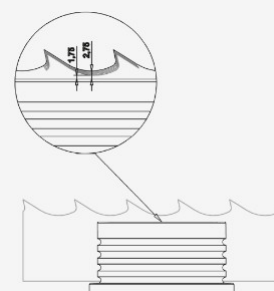



TECHNICAL SPECIFICATION	WORKING CONDITIONS
Steel grade / Blade hardness: QSX / 460 - 490 HV	Blade tension: acc. to technical specification of machine manufacturer
Tooth type / Tooth hardness: Carbide / 1610 - 1750 HV	Feed rate: Up to 35 m/min
Tooth rake angle: 10 / 30	Blade speed: Up to 50 m/s
	Working time: up to 20 h between servicing



WIDTH H (mm)	THICKNESS T (mm)	PITCH P (mm)
	1,1	22
38	✓	✓

On request we provide band saw blades of different dimensions.

SHARPENING (TOOTH)

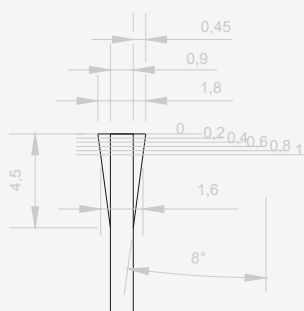

SHARPENING (TOOTH GULLET)

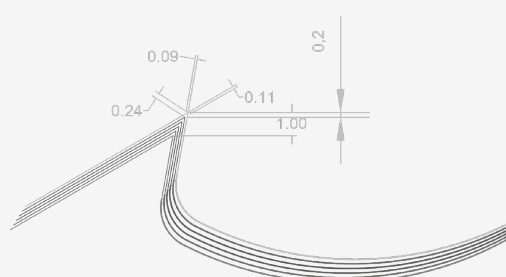

ADJUSTMENT OF THE TOOTH ROOT REGARDING THE ROLLER

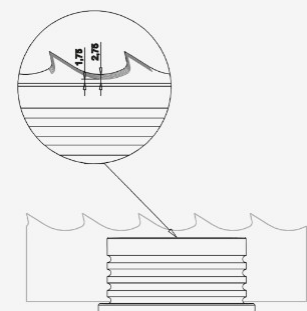

M42



TECHNICAL SPECIFICATION	WORKING CONDITIONS
Steel grade / Blade hardness: QSX / 490 - 520 HV	Blade tension: acc. to technical specification of machine manufacturer
Tooth type / Tooth hardness: High-speed steel M42 / 940-990 HV	Feed rate: Up to 30 m/min
Tooth rake angle: 10 / 30 9/29	Blade speed: Up to 50 m/s
	Working time: up to 8 h between servicing



WIDTH H (mm)	THICKNESS T (mm)	PITCH P (mm)
	1,07	22,22
34	✓	✓
38	✓	✓
50	✓	✓

On request we provide band saw blades of different dimensions.

■ SHARPENING (TOOTH)

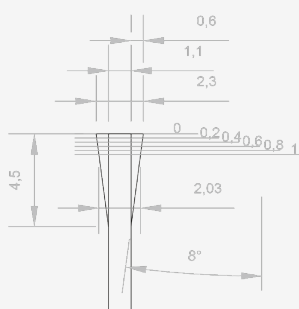

■ SHARPENING (TOOTH GULLET)

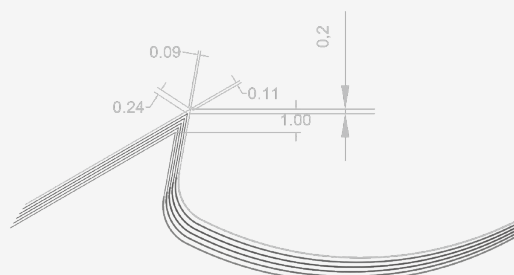

■ ADJUSTMENT OF THE TOOTH ROOT REGARDING THE ROLLER

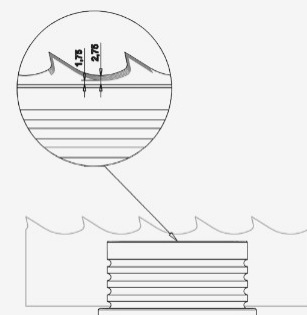

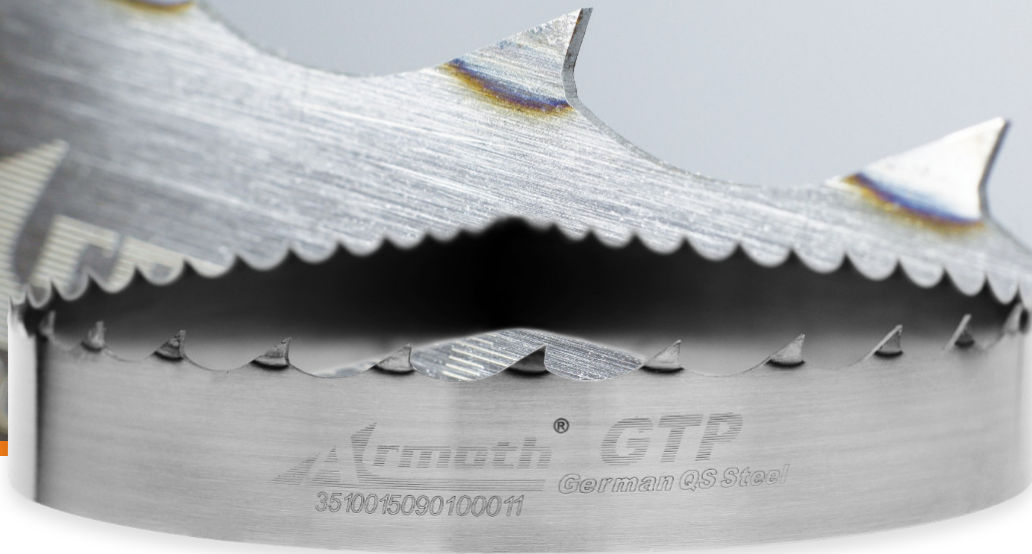

TECHNICAL SPECIFICATION	WORKING CONDITIONS
Steel grade / Blade hardness: QSX / 460-490 HV	Blade tension: acc. to technical specification of machine manufacturer
Tooth type / Tooth hardness: Induction hardened / up to 750 HV	Feed rate: Up to 30 m/min
Tooth rake angle: 10 / 30 9/29	Blade speed: Up to 50 m/s
	Working time: up to 4 h between servicing



WIDTH H (mm)	THICKNESS T (mm)		PITCH P (mm)		
	1,0	1,1	1,15	1,25	22,22
32		✓			✓
35	✓	✓	✓		✓
40	✓	✓	✓	✓	✓
50	✓	✓			✓

On request we provide band saw blades of different dimensions.

■ SHARPENING (TOOTH)

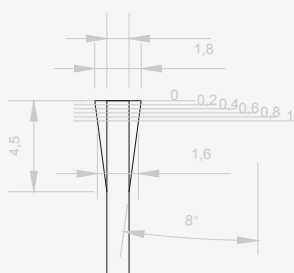

■ SHARPENING (TOOTH GULLET)

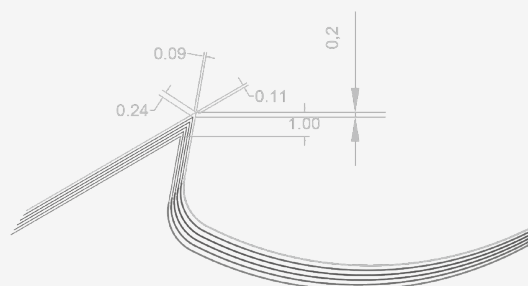

■ ADJUSTMENT OF THE TOOTH ROOT REGARDING THE ROLLER

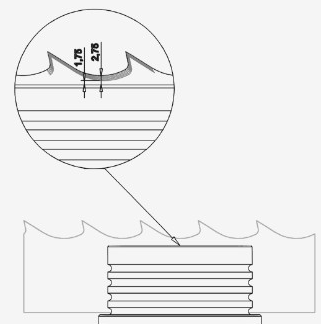



TECHNICAL SPECIFICATION	WORKING CONDITIONS
Steel grade / Blade hardness: Q SX / 440-460 HV	Blade tension: acc. to technical specification of machine manufacturer
Tooth type / Tooth hardness: Induction hardened / up to 750 HV	Feed rate: Up to 30 m/min
Tooth rake angle: 10 / 30	Blade speed: Up to 50 m/s
	Working time: up to 4 h between servicing



WIDTH H (mm)	THICKNESS T (mm)			PITCH P (mm)
	1,0	1,1	1,15	22,22
32		✓		✓
35	✓	✓	✓	✓
40	✓	✓	✓	✓
50		✓		✓

On request we provide band saw blades of different dimensions.

■ SHARPENING (TOOTH)

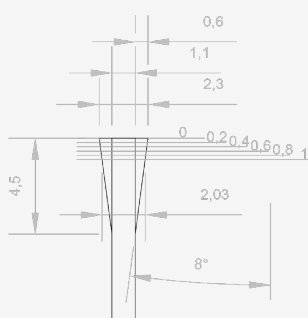

■ SHARPENING (TOOTH GULLET)

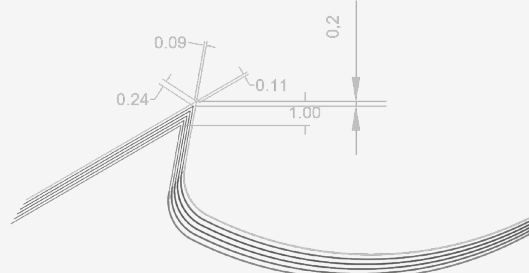

■ ADJUSTMENT OF THE TOOTH ROOT REGARDING THE ROLLER

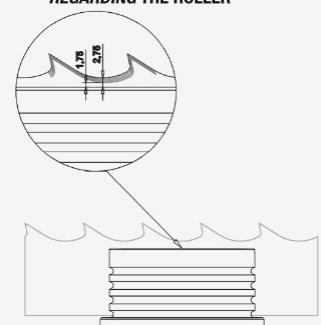

X-Cut

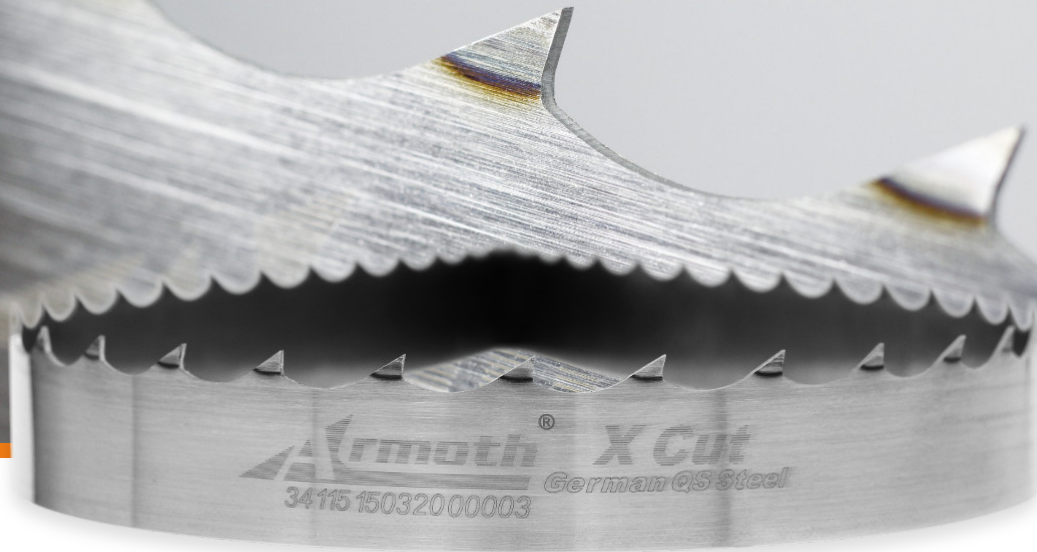

TECHNICAL SPECIFICATION	WORKING CONDITIONS
Steel grade / Blade hardness: QSX / 460-490 HV	Blade tension: acc. to technical specification of machine manufacturer
Tooth type / Tooth hardness: Induction hardened / up to 750 HV	Feed rate: Up to 30 m/min
Tooth rake angle: 10/30 9/29	Blade speed: Up to 50 m/s
	Working time: up to 4 h between servicing



WIDTH H (mm)	THICKNESS T (mm)				PITCH P (mm)
	1,0	1,1	1,15	1,25	22,22
32		✓	✓		✓
34	✓	✓	✓		✓
38	✓	✓	✓	✓	✓
50	✓	✓			✓

On request we provide band saw blades of different dimensions.

■ SHARPENING (TOOTH)

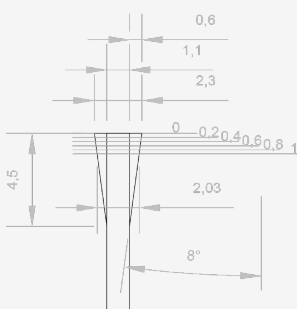

■ SHARPENING (TOOTH GULLET)

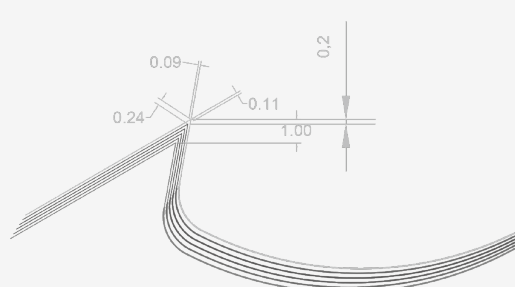

■ ADJUSTMENT OF THE TOOTH ROOT REGARDING THE ROLLER

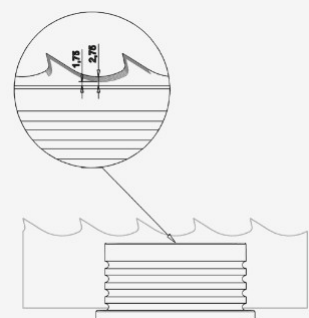

Durable

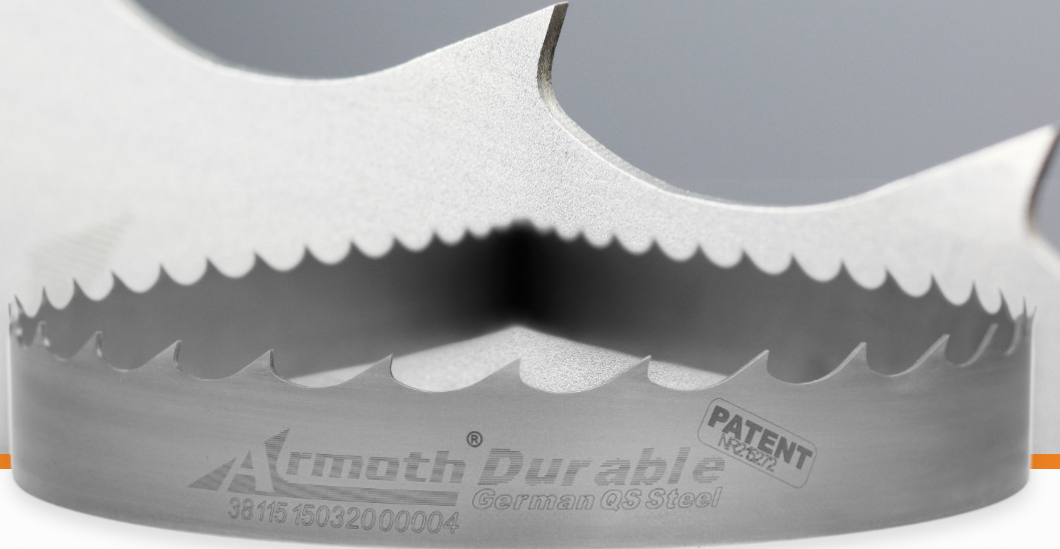

TECHNICAL SPECIFICATION	WORKING CONDITIONS
Steel grade / Blade hardness: QSX / 460-490 HV	Blade tension: acc. to technical specification of machine manufacturer
Tooth type / Tooth hardness: Induction hardened / up to 800 HV	Feed rate: Up to 30 m/min
Tooth rake angle: 10 / 30 9/29	Blade speed: Up to 50 m/s
	Working time: up to 4 h between servicing



WIDTH H (mm)	THICKNESS T (mm)		PITCH P (mm)		
	1,0	1,1	1,15	1,25	22,22
34	✓	✓	✓		✓
38	✓	✓	✓	✓	✓
50	✓	✓			✓

On request we provide band saw blades of different dimensions.

■ SHARPENING (TOOTH)

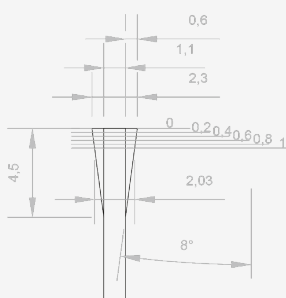

■ SHARPENING (TOOTH GULLET)

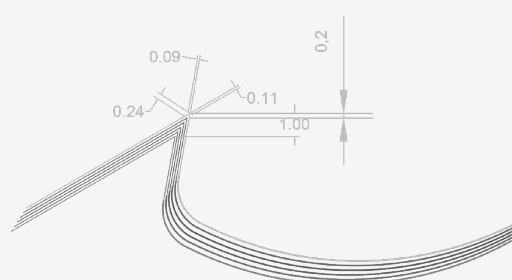

■ ADJUSTMENT OF THE TOOTH ROOT REGARDING THE ROLLER

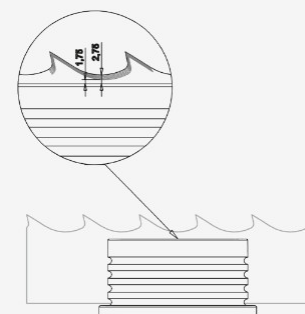

Champion

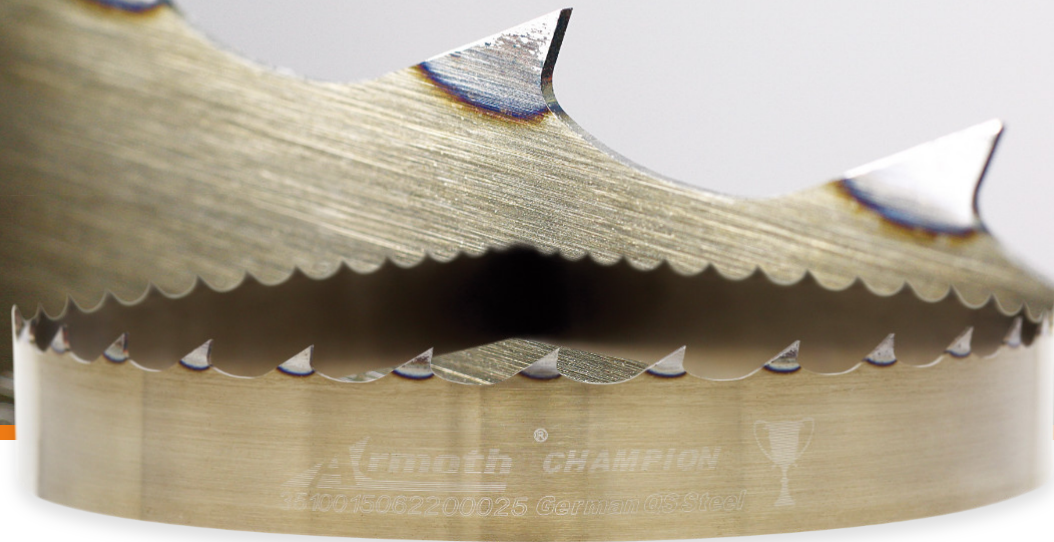

TECHNICAL SPECIFICATION	WORKING CONDITIONS
Steel grade / Blade hardness: Qsx / 440-460 HV	Blade tension: acc. to technical specification of machine manufacturer
Tooth type / Tooth hardness: Induction hardened / up to 750 HV	Feed rate: Up to 30 m/min
Tooth rake angle: 10 / 30	Blade speed: Up to 50 m/s
	Working time: up to 4 h between servicing



WIDTH H (mm)	THICKNESS T (mm)		PITCH P (mm)
	1,07	1,14	22,22
35	✓		✓
38		✓	✓

On request we provide band saw blades of different dimensions.

SHARPENING (TOOTH)

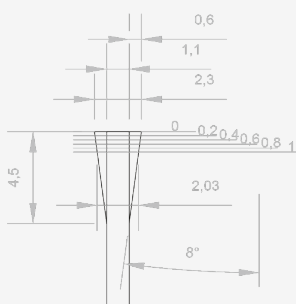

SHARPENING (TOOTH GULLET)

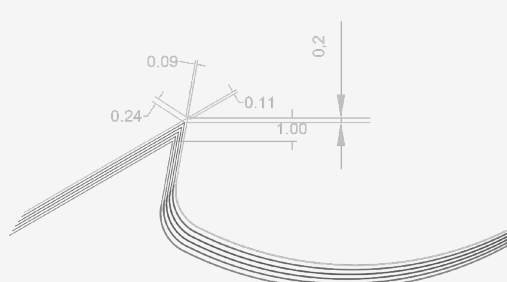

ADJUSTMENT OF THE TOOTH ROOT REGARDING THE ROLLER

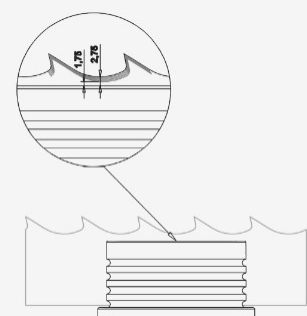

Manufacturer of cutting tools for the wood industry



📍 QSGS Technology, ul. Łużycka 4, 07-410 Ostrołęka, POLSKA
☎ +48 29 764 43 15, fax + 48 29 769 43 86
✉ info@armoth.eu, orders@armoth.eu